

P56400S

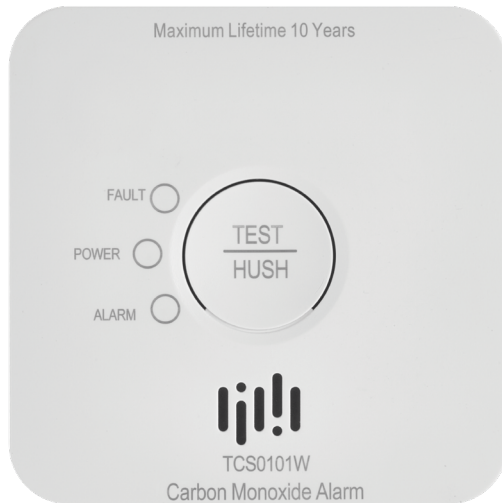

GB | CO Detector



Contents

Safety Instructions and Warnings	2
Technical Specifications	3
Device Description	3
Installation and Assembly	4
Getting Started	5
Mobile Application	8
Controls and Functions	10
Troubleshooting FAQ	12

Safety Instructions and Warnings



Read the user manual before using the device.



Follow the safety instructions in the manual.

- This manual contains important safety information regarding the installation and operation of the warning device.
- Read the manual carefully and store it in a safe place for future use or for when the device is passed on to another user.
- The installation of a warning device (alarm) for monitoring CO concentration is not a substitute for correct installation, use and maintenance of fuel-burning devices, including proper ventilation and exhaust systems.
- This warning device for monitoring CO concentration is designed for protecting persons against the acute effects of short-term exposure to carbon monoxide, but cannot fully protect persons with particular health conditions. When in doubt, consult your physician.
- Long-term exposure to low concentrations of CO (>10 ppm) can cause chronic effects. When in doubt, consult your physician.
- The device is designed solely to detect carbon monoxide (CO), it does not detect other gases. If you are unsure what caused the alarm to go off, always assume the alarm was triggered by dangerous levels of carbon monoxide and evacuate the inhabitants.
- Do not tamper with the internal electrical circuits of the product – doing so may damage the product and will automatically void the warranty. The product should only be repaired by a qualified professional.
- To clean the product, use a soft damp cloth. Do not use solvents or detergents – they could scratch the plastic parts and cause corrosion of the electric circuits.
- Do not use the device in the proximity of devices that generate electromagnetic fields.
- Do not expose the device to excessive force, impact, dust, high temperatures or humidity – these may cause the device to malfunction or may deform its plastic parts.
- Do not insert any objects into the openings on the device.
- Do not submerge the device in water.
- Protect the device from falls or impacts.
- Only use the device in accordance with the instructions provided in this manual.
- The manufacturer is not liable for damage caused by improper use of the device.
- This appliance is not intended for use by persons (including children) whose physical, sensory or mental disability, or lack of experience and expertise prevents safe use, unless they are supervised or instructed in the use of the appliance by a person responsible for their safety. Children must always be supervised to ensure they do not play with the appliance.

EMOS spol. s r. o. hereby declares that device type P56400S complies with Directive 2014/53/EU. The full wording of the EU declaration of conformity is available at <http://www.emos.eu/download>.

The device can be operated on the basis of general authorization no. VO-R/10/07.2021-8, as amended.

Service centre:

EMOS spol. s r.o.
Lipnická 2844
Přerov
750 02

Manufacturing plant:

Zhejiang Jiaboer Electronic Technology Co., Ltd
No. 72, Dayantou, Tingshan Village, Dayuan Town, Fuyang District, Hangzhou City, Zhejiang Province, China



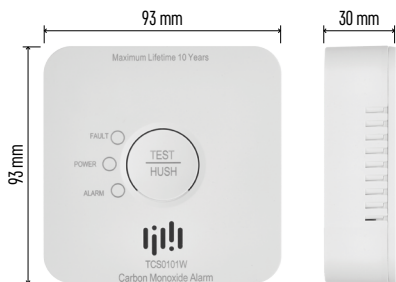

Technical Specifications

Detected gas: carbon monoxide (CO)

Sensor type: electrochemical cell

In accordance with standard ČSN EN 50291-1 ed.2:18

Service life: 10 years

B-type device

Operating temperature and humidity: -10 to +40 °C, 15 to 93 % (without condensation)

Enclosure rating: IP20

Acoustic signalisation: >85 dB at a range of 3 m

Power supply: 2× 1.5 V AA

Expected operating lifetime of the battery:
2 years

Power consumption:

Stand-by mode: <10 µA

Alarm mode: <60 mA

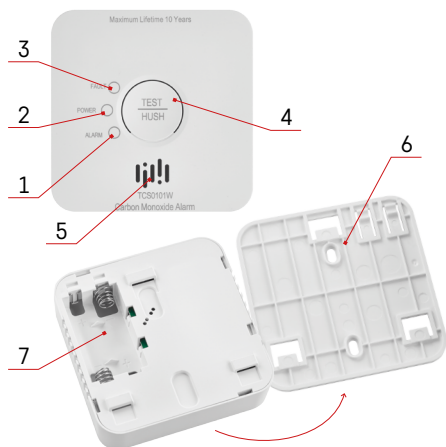

Device Description

1 – red LED: ALARM

2 – green LED: POWER

3 – yellow LED: FAULT

4 – TEST/HUSH button

5 – loud siren

6 – mounting pad

7 – battery compartment



Installation and Assembly

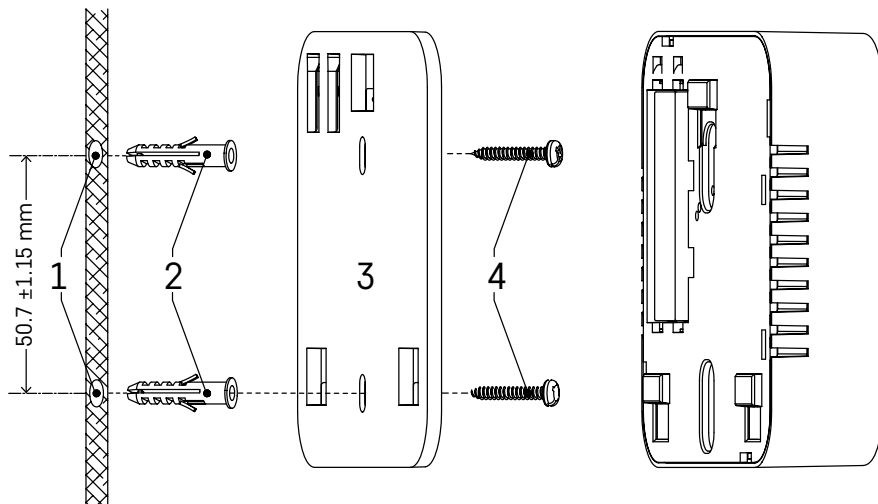

- 1 – holes in the wall
- 2 – wall plugs
- 3 – mounting pad
- 4 – screws

Drill two holes ($\varnothing 5$ mm) into the wall (1); the distance between the holes should be 52 mm. Insert the attached wall plugs (2) into the holes, place the mounting pad (3) and attach it to the wall using screws (4).

Put batteries into the detector and test its functionality, see Test Mode.

If the detector is functional, fit the back of the detector onto the mounting pad.



Getting Started

Insert batteries (2× 1.5 V AA) into the battery compartment on the back of the device. Only use alkaline batteries of the same type; do not use 1.2 V rechargeable batteries due to their low voltage.

Warning:

The mounting pad will not fit unless both batteries are in place!

After the batteries are inserted, all three diodes (ALARM, POWER, FAULT) will flash one after another.

The detector will automatically enter pre-heating mode for 5 minutes (red ALARM LED flashes 1× every 4 seconds).

After 5 minutes, the green POWER LED will flash 1× every 50 seconds to indicate that the detector is functional.

Test Mode

You can test the functioning of the alarm whenever needed or after every battery change.

Press and hold the TEST/HUSH button. The alarm will simultaneously beep and flash its red ALARM LED 4× every 5 seconds.

Release the TEST/HUSH button; the alarm is ready for use.

Activate test mode 1× a week to make sure the alarm is functional.

Note:

The acoustic and optical alarm during testing is only used as indication that the alarm is operational. It does not mean that the presence of CO has been detected.

Fault State

If the alarm is in a fault state, it is not operational and does not measure CO levels in the room.

Fault state is indicated by simultaneous beeping/flashing of the yellow FAULT LED 2× every 50 seconds.

Replace the batteries immediately.

Test the detector's functionality.

The acoustic signal can be temporarily muted for 14 hours using the TEST/HUSH button (then the acoustic signal reactivates).

The yellow FAULT LED will continue indicating a fault.

If the fault state persists even after batteries have been replaced, contact a service centre.

Low Batteries

Low batteries in the alarm are indicated by simultaneous beeping/flashing of the yellow FAULT LED 1× every 50 seconds.

The alarm is not operational and does not measure CO levels in the room.

Replace the batteries immediately. Run a function test.

It is recommended to replace batteries 1× a year as a precaution.

The acoustic signal can be temporarily muted for 14 hours using the TEST/HUSH button (then the acoustic signal reactivates).

The yellow FAULT LED will continue indicating a fault.

End of Life of the Detector

After 10 years since production, the detector must be replaced and its use must be discontinued.

The production and replacement date is listed on the back on the data plate.

The end of life of the device is indicated as follows:

Simultaneous beeping/flashing of the yellow FAULT LED 3× every 50 seconds.

The acoustic signal can be temporarily muted for 14 hours using the TEST/HUSH button (then the acoustic signal reactivates).

The yellow FAULT LED will continue indicating a fault.

CO WARNING

If the detector detects dangerous amounts of CO, an optical and acoustic warning will be activated.

The detector will simultaneously beep/flash the RED ALARM LED 4× every 5 seconds.

The CO level (0 až 999 ppm) will be displayed in the app.

The warning will be active for as long as CO is present, until CO levels drop below the danger level or the detector is silenced manually.

The acoustic signal can be temporarily muted for 14 hours using the TEST/HUSH button (then the acoustic signal reactivates).

The yellow FAULT LED will continue indicating a fault.

Manual Silencing of the Alarm upon CO Detection

The acoustic signal for CO presence can be temporarily silenced.

Press the TEST/HUSH button to silence the acoustic signal for 10 minutes.

The red ALARM LED will continue flashing.

Note:

The warning will reactivate within 10 minutes of pressing the TEST/HUSH button as long as the CO level is equal to or above 150 ppm.

What to Do When CO Is Detected in the Building

If CO is detected in the building, keep calm and do the following:

Stop using all fuel-burning devices and turn them off if possible.

Silence the alarm by pressing the TEST/HUSH button.

Make all persons on the premises aware of the situation!

Open all doors and windows and air the area.

If the alarm persists, leave the premises.

Call 112 and the service organisation for your gas appliance and ask the supplier for aid in finding and eliminating the source of carbon monoxide.

Check that all persons have left the premises!

Leave the doors and windows open until the alarm stops.

Get medical attention for all persons suffering from symptoms of carbon monoxide poisoning (headaches, nausea).

Inform the doctors of the suspected carbon monoxide inhalation.

Do not use the fuel-burning appliances until they have been checked by a qualified person.

Note:

Aside from fuel-burning devices, there can be other sources of carbon monoxide, such as emission from a smouldering fire, large amount of tobacco smoke, etc.

What Is Carbon Monoxide (CO)

Carbon monoxide (CO) is an odourless, invisible, highly poisonous gas. It is generated through incomplete combustion of fuels, such as wood, wooden coal, coal, fuel oil, paraffin, gasoline, natural gas, propane, butane, etc., and from cigarette smoke. A dangerous concentration of CO can form if the fuel-burning device is faulty or not properly maintained, if the flue is blocked or the room insufficiently ventilated. The seriousness of poisoning from CO inhalation depends on the concentration (listed as number of particles per million, ppm) and the duration of exposure.

Concentration	Symptoms
100 ppm	No symptoms – no danger
200 ppm	Slight headaches
400 ppm	Strong headaches after 1–2 hours
800 ppm	Strong headaches after 45 minutes, nausea, faintness and unconsciousness after 2 hours, death within 3 hours
1 000 ppm	Dangerous concentration - unconsciousness after 1 hour
1 600 ppm	Nausea, strong headaches and dizziness after 20 minutes, death within 1 hour
3 200 ppm	Nausea, strong headaches and dizziness after 5–10 minutes, unconsciousness after 30 minutes
6 400 ppm	Nausea, strong headaches and dizziness after 1–2 minutes, unconsciousness after 10–15 minutes
12 800 ppm	Instant unconsciousness, risk of death after 1–2 minutes

The device must be installed by a competent person. Ideally, the warning device should be located in every room with a fuel-burning device. It is strongly recommended to also install warning devices in bedrooms and rooms where you spend a lot of time.

If the warning device is installed in the same room as a fuel-burning device:

- Place the warning device in the vicinity of the ceiling and above the level of the top edge of windows and doors.
- When installing onto the ceiling, the warning device must be located at least 30 cm away from walls.
- When installing onto a wall, the warning device must be located at least 15 cm from the ceiling and 180 cm from the floor.
- Do not install the warning device in rooms with vaulted ceilings, gable roof etc.
- Do not install the warning device in the vicinity of vents or windows/doors that lead outside.
- Do not install the warning device behind curtains/furniture; doing so would decrease the ability of the device to correctly detect the CO level.
- Do not install the warning device in an area with temperature lower than -10 °C or higher than 40 °C.
- If possible, install the warning device approximately at eye level for ease of checking the LED indicators.
- If you are only installing one warning device, place it in the vicinity of the bedroom (not in the basement etc.).
- Make sure that you can hear all the installed warning devices from the room where you sleep.
- The warning device must be located at a distance of 1 m to 3 m horizontally from the nearest edge of a potential CO source.
- The ventilation openings of the warning device must not be covered up.
- Do not spray aerosol agents in the vicinity of or onto the device.
- Do not paint the warning device.

If the warning device is located in a room without a fuel-burning device, it must be located in the vicinity of the breathing area of the persons residing in the room. In open-plan rooms where people both sleep and spend their time, such as one-room flats, caravans or boats, the device must be located as far away as possible from cookers while also being in the vicinity of the space reserved for sleeping.



Mobile Application



Download the EMOS GoSmart app for your device. Tap the Log In button if you've used the app before. Otherwise, tap the Sign Up button and register.

Pairing with the App

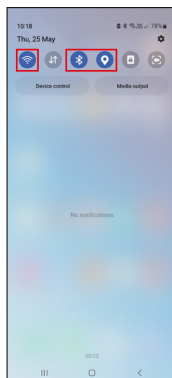
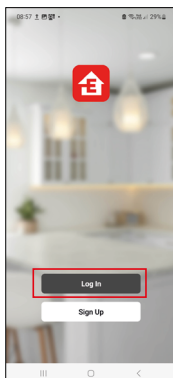

Insert batteries (2x 1.5 V AA) into the detector. Press the TEST button 4x; the green LED will start flashing rapidly; the detector is now in pairing mode. Activate Bluetooth and GPS on your mobile device.

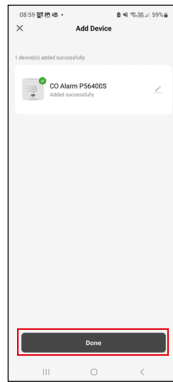
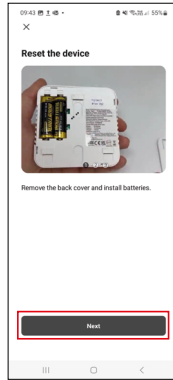
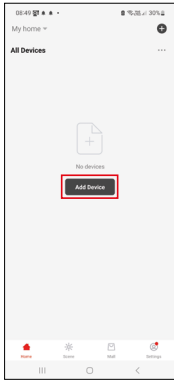

Tap Add Device in the app.

Tap the GoSmart list on the left and tap the P56400S icon.

Follow the instructions in the app and enter the name and password for your 2.4 GHz Wi-Fi network.

The detector will pair with the app within 2 minutes; the green LED will stop flashing.

Note:

If the detector fails to pair, repeat the process.

5 GHz Wi-Fi networks are not supported.

Inserting/Replacing Batteries

1. Remove the cover of the battery compartment on the back of the detector.
2. Remove the old batteries.
3. Insert 2× new 1.5 V AA batteries. Make sure to observe the correct polarity.
4. Close the cover.

If batteries are protected by a safety film, remove it first.

Only use alkaline batteries of the same type; do not use old and new batteries at the same time; do not use 1.2V rechargeable batteries.



Controls and Functions

Application Menu

- 1 – Settings
- 2 – Scene creation
- 3 – Records
- 4 – CO level in ppm
- 5 – Detector status
- 6 – Advanced settings

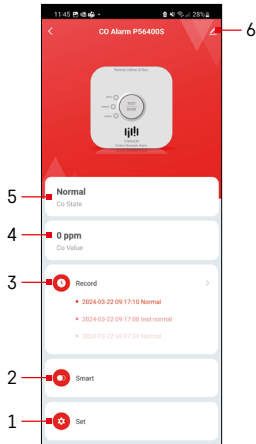

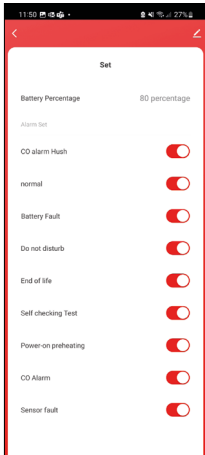

Settings

Display notifications in the app:

- **Battery percentage** – battery state of charge
- **CO alarm Hush** – display notifications about silencing of the alarm
- **Normal** – display notifications about normal status of the detector
- **Battery fault** – display notifications about low battery
- **Do not disturb** – display notifications about silencing of low battery warnings
- **End of life** – display notifications about the end of life of the detector
- **Self checking Test** – display notifications about performed test mode
- **Power-on preheating** – display notifications about pre-heating of the detector
- **CO Alarm** – display notifications about CO alarms
- **Sensor fault** – display notifications about fault state of the sensor

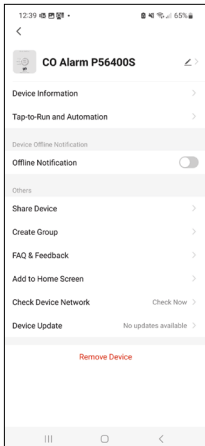

Advanced Settings

- **Device information** – basic information about the device and its owner.
- **Tap-to-Run and Automation** – View scenes and automations assigned to the device.
- **Offline Notification** – to avoid constant notifications, a notification will be sent if the device remains offline for more than 30 minutes.
- **Share Device** – option for sharing the administration of the device with another user.
- **Create Group** – creates a group of multiple devices that can be controlled together.
- **FAQ & Feedback** – shows frequently asked questions and their solutions and provides the option to send us a question/suggestion/feedback directly.
- **Add to Home Screen** – adds the icon for the device to the home screen of your phone. That way, you no longer need to open the device through the app; you simply tap the newly added icon and you will be redirected straight to the device.
- **Check Device Network** – run a test of the Wi-Fi network.
- **Device Update** – updates the device



Troubleshooting FAQ

Test mode is not working:

- Check battery voltage or replace batteries.

The detector beeps/ flashes its LEDs at different times:

- The detector may be in the following states, see descriptions in the manual above:
Fault state, low batteries, end of life of the alarm, alert to presence of CO.

The detector fails to pair with the app:

- Check that the detector and the Wi-Fi router are working correctly.
- The devices must be close to each other during pairing.
- Pair only with 2.4 GHz networks.

